

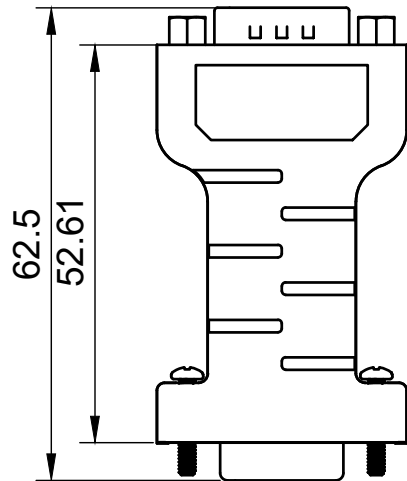

Basic Measurements
Port Detailed

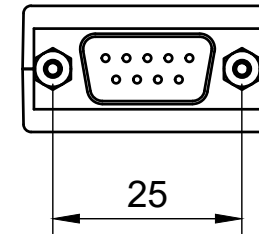
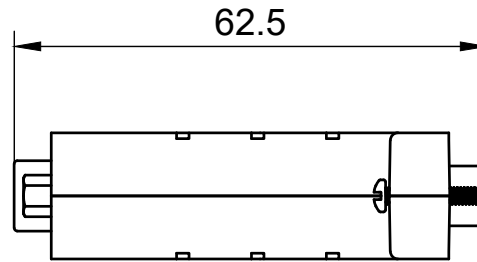
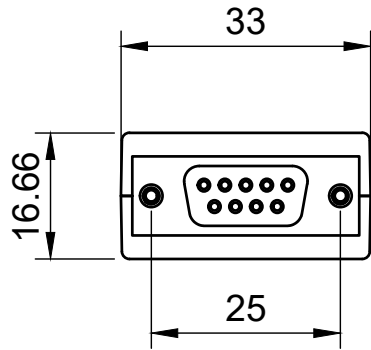
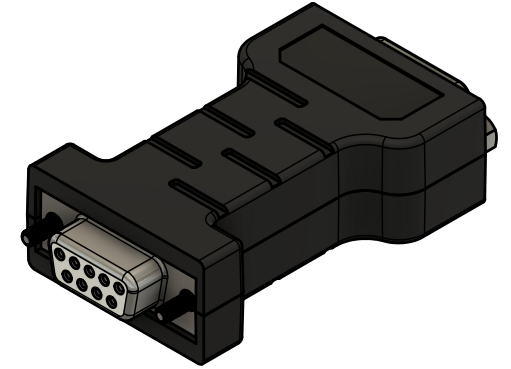

		Model #: GM-1010-B	
Drawn by: Leo Pinto		Scale: 1:1	Units: mm
Drawn Date: 8/25/2021		Tolerance: +/- 0.15mm	
Notes:		Contact: support@gearmo.com	
		Web: gearmo.com	
		A4	1/1